

Keysight 2-Port and 4-Port PNA Network Analyzer

N5227A 10 MHz to 67 GHz

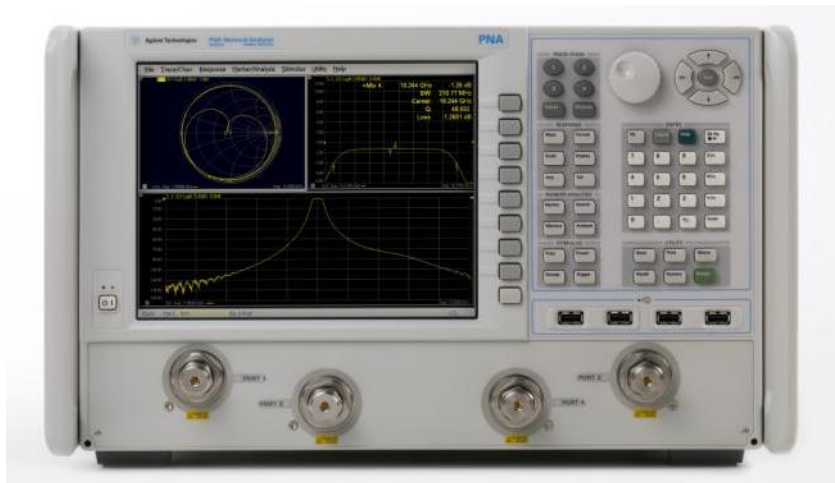

Data Sheet
and Technical
Specifications for
Option 210 and 410

Documentation Warranty

THE MATERIAL CONTAINED IN THIS DOCUMENT IS PROVIDED "AS IS," AND IS SUBJECT TO BEING CHANGED, WITHOUT NOTICE, IN FUTURE EDITIONS. FURTHER, TO THE MAXIMUM EXTENT PERMITTED BY APPLICABLE LAW, KEYSIGHT DISCLAIMS ALL WARRANTIES, EITHER EXPRESS OR IMPLIED WITH REGARD TO THIS MANUAL AND ANY INFORMATION CONTAINED HEREIN, INCLUDING BUT NOT LIMITED TO THE IMPLIED WARRANTIES OF MERCHANTABILITY AND FITNESS FOR A PARTICULAR PURPOSE. KEYSIGHT SHALL NOT BE LIABLE FOR ERRORS OR FOR INCIDENTAL OR CONSEQUENTIAL DAMAGES IN CONNECTION WITH THE FURNISHING, USE, OR PERFORMANCE OF THIS DOCUMENT OR ANY INFORMATION CONTAINED HEREIN. SHOULD KEYSIGHT AND THE USER HAVE A SEPARATE WRITTEN AGREEMENT WITH WARRANTY TERMS COVERING THE MATERIAL IN THIS DOCUMENT THAT CONFLICT WITH THESE TERMS, THE WARRANTY TERMS IN THE SEPARATE AGREEMENT WILL CONTROL.

DFARS/Restricted Rights Notice

If software is for use in the performance of a U.S. Government prime contract or subcontract, Software is delivered and licensed as "Commercial computer software" as defined in DFAR 252.227-7014 (June 1995), or as a "commercial item" as defined in FAR 2.101(a) or as "Restricted computer software" as defined in FAR 52.227-19 (June 1987) or any equivalent agency regulation or contract clause. Use, duplication or disclosure of Software is subject to Keysight Technologies' standard commercial license terms, and non-DOD Departments and Agencies of the U.S. Government will receive no greater than Restricted Rights as defined in FAR 52.227-19(c)(1-2) (June 1987). U.S. Government users will receive no greater than Limited Rights as defined in FAR 52.227-14 (June 1987) or DFAR 252.227-7015 (b)(2) (November 1995), as applicable in any technical data.

DFARS/Restricted Rights Notice	2
Definitions.....	5
Corrected System Performance	6
System Dynamic Range and Receiver Dynamic Range	6
Table 1. System Dynamic Range and Receiver Dynamic Range, Option 210, 410	7
N5227A Corrected System Performance, Option 210, 410	8
Table 2a. N5227A with 85058B Calibration Kit	8
Table 2b. N5227A with N4694A 2-Port Electronic Calibration Module	10
Uncorrected System Performance	12
Table 3a. Error Terms (dB), All Ports, Option 210, 410 - Specifications ...	12
Table 3b. Error Terms (dB), All Ports, Option 210, 410 - Typical.....	12
Test Port Output	13
Table 4. Frequency Information, Option 210, 410	13
Table 5. Maximum Leveled Power (dBm) - Option 210, 410	14
Table 6. Power Level Accuracy (dB), Option 210, 410.....	15
Table 7a. Power Level Linearity (dB), Option 210, 410 - Specification	15
Table 7b. Power Level Linearity (dB), Option 210, 410 - Specification	15
Table 8. Power Sweep Range (dB) – Option 210, 410.....	16
Table 9. Nominal (Preset) Power (dBm)	17
Table 10. Power Resolution and Maximum/Minimum Settable Power, Option 210, 410	17
.....	
Table 11. 2 nd and 3 rd Harmonics at Max Specified Power (dBc), Option 210, 410	17
Table 12. Non-Harmonic Spurs at Nominal Power (dBc), Option 210, 410 - Typical	17
Table 13. Phase Noise (dBc/Hz), Option 210, 410 - Typical	18
Test Port Input	18
Table 14. Test Port Noise Floor (dBm) @ 10 Hz IFBW, Option 210, 410	18
Table 15. 0.1 dB Receiver Compression at Test Port (dBm), Option 210, 410	19
Table 16. Receiver Compression at Test Port Power - Specification	19
Table 17. N5227A Trace Noise Magnitude (dB rms).....	20
Table 18. N5227A Trace Noise Phase (deg rms).....	20
Table 19. Reference Level Magnitude, Option 210, 410 - Specification...	21
Table 20. Stability vs. Temperature, Option 210, 410 - Typical.....	21
Table 21. Stability vs. Time, Option 210, 410 – Specification	21

Table 22. Damage Input Level, Option 210, 410.....	22
Dynamic Accuracy	22
Table 23. N5227A Dynamic Accuracy	22
Table 24. Group Delay - Typical.....	27
General Information.....	28
Table 25. Miscellaneous Information.....	28
Table 26. Front Panel Information, Option 210, 410	28
Table 26. (Continued) Front Panel Information, Option 210, 410.....	29
Table 27. Rear Panel Information, Option 210, 410.....	29
Table 27. (Continued) Rear Panel Information, Option 210, 410.....	30
Table 27. (Continued) Rear Panel Information, Option 210, 410.....	31
Table 27. (Continued) Rear Panel Information, Option 210, 410.....	32
Table 28. Analyzer Dimensions and Weight.....	33
Regulatory and Environmental Information	33
Measurement Throughput Summary	34
Table 29. Typical Cycle Time (ms) for Measurement Completion, All Models and Options	34
Table 30. Typical Cycle Time (ms) for Full-Span Measurement Completion	35
Table 31. Cycle Time vs. IF Bandwidth - Typical	35
Table 32. Cycle Time vs. Number of Points - Typical.....	36
Table 33. Data Transfer Time (ms) - Typical	37
Test Set Block Diagrams.....	38
N5227A Option 210 (2-port metrology configuration)	38
N5227A Option 410 (4-port metrology configuration)	38
Receiver Block Diagram	39

This is a complete list of the technical specifications for the N5227A PNA network analyzer with the following options:

2-Port Model

Option 210 - 2-port, single source, with metrology configuration

4-Port Model

Option 410 - 4-port, dual source, with metrology configuration

See block diagrams for all models and options beginning on page 38.

Notes

This document provides technical specifications for the 85058B and N4694A calibration kits.

Please download our free Uncertainty Calculator from http://www.keysight.com/find/na_calculator to generate the curves for your calibration kit and PNA setup.

Typical performance information between 67 GHz and 70 GHz is shown in this document where available. The performance is degraded at particular frequencies in this range due to the modes of the 1.85 mm connectors used in the analyzer, test port cables and adapters.

For all tables in this data sheet, the specified performance at the exact frequency of a break is the degraded value of the two specifications at that frequency.

Definitions

All specifications and characteristics apply over a 25 °C ±5 °C range (unless otherwise stated) and 90 minutes after the instrument has been turned on.

Specification (spec.): Warranted performance. Specifications include guardbands to account for the expected statistical performance distribution, measurement uncertainties, and changes in performance due to environmental conditions.

Characteristic (char.): A performance parameter that the product is expected to meet before it leaves the factory, but that is not verified in the field and is not covered by the product warranty. A characteristic includes the same guardbands as a specification.

Typical (typ.): Expected performance of an average unit which does not include guardbands. It is not covered by the product warranty.

Nominal (nom.): A general, descriptive term that does not imply a level of performance. It is not covered by the product warranty.

Calibration: The process of measuring known standards to characterize a network analyzer's systematic (repeatable) errors.

Corrected (residual): Indicates performance after error correction (calibration). It is determined by the quality of calibration standards and how well "known" they are, plus system repeatability, stability, and noise.

Uncorrected (raw): Indicates instrument performance without error correction. The uncorrected performance affects the stability of a calibration.

Standard: When referring to the analyzer, this includes no options unless noted otherwise.

Corrected System Performance

The specifications in this section apply for measurements made with the N5227A PNA network analyzer with the following conditions:

- 10 Hz IF bandwidth
- No averaging applied to data
- Isolation calibration with an averaging factor of 8

System Dynamic Range and Receiver Dynamic Range

- **System Dynamic Range** is defined as the specified source maximum output power (spec) minus the noise floor (spec).
- **Receiver Dynamic Range** is defined as the test port compression at 0.1 dB (typical) minus the noise floor (typical).

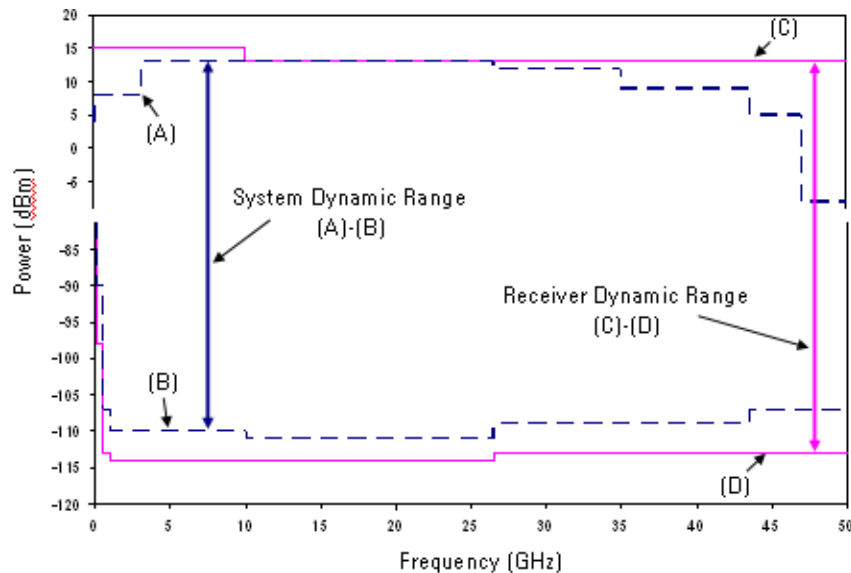

NOTE:

The effective dynamic range must take measurement uncertainties and interfering signals into account. This set-up should only be used when the receiver input will never exceed its maximum receiver input. When the analyzer is in segment sweep mode, it can have predefined frequency segments which will output a higher power level when the extended dynamic range is required (i.e. devices with high insertion loss), and reduced power when the maximum receiver input level will occur (i.e. devices with low insertion loss). The extended range is only available in one-path transmission measurements.

It may typically be degraded at particular frequencies below 500 MHz due to spurious receiver residuals.

Table 1. System Dynamic Range and Receiver Dynamic Range, Option 210, 410

Description	Specification			Typical			
	System Dynamic Range (dB) (A)-(B)	Max Leveled Output Power (dBm) (A)	Test Port Noise Floor (dBm) (B)	System Dynamic Range (dB)	Receiver Dynamic Range (dB) (C)-(D)	0.1 dB Compression at Test Port (dBm) (C)	Test Port Noise Floor (dBm) (D)
10 MHz to 50 MHz	76	6	-70	90	91	15	-76
50 MHz to 100 MHz	99	7	-92	111	112	15	-97
100 MHz to 500 MHz	108	7	-101	120	118	12	-106
500 MHz to 1 GHz	117	7	-110	130	127	12	-115
1 GHz to 2 GHz	121	7	-114	133	131	12	-119
2 GHz to 3.2 GHz	121	7	-114	131	131	12	-119
3.2 GHz to 10 GHz	121	7	-114	132	131	12	-119
10 GHz to 13.5 GHz	120	6	-114	132	132	12	-120
13.5 GHz to 16 GHz	122	6	-116	134	133	12	-121
16 GHz to 19 GHz	121	5	-116	132	133	12	-121
19 GHz to 20 GHz	121	5	-116	132	133	12	-121
20 GHz to 24 GHz	121	5	-116	131	133	12	-121
24 GHz to 26.5 GHz	122	5	-117	130	133	12	-121
26.5 GHz to 30 GHz	110	4	-106	121	124	12	-112
30 GHz to 32 GHz	109	3	-106	120	123	11	-112
32 GHz to 35 GHz	110	4	-106	121	123	11	-112
35 GHz to 40 GHz	103	-1	-104	117	121	11	-110
40 GHz to 43.5 GHz	106	5	-101	114	119	11	-108
43.5 GHz to 50 GHz	106	5	-101	115	119	11	-108
50 GHz to 60 GHz	106	5	-101	114	118	11	-107
60 GHz to 64 GHz	106	5	-101	115	119	11	-108
64 GHz to 67 GHz	106	5	-101	116	119	11	-108
67 GHz to 70 GHz	--	--	--	114	117	11	-106

N5227A Corrected System Performance, Option 210, 410

Note: For any S_{ii} reflection measurement:

- $S_{jj} = 0$.

For any S_{ij} transmission measurement:

- $S_{ji} = S_{ij}$ when $S_{ij} \leq 1$
- $S_{ji} = 1/S_{ij}$ when $S_{ij} > 1$
- $S_{kk} = 0$ for all k

Applies to the N5227A Option 210 or 410 analyzers, N4697F flexible test port cable set, and a full 2-port calibration. Also applies to the following condition:

Environmental temperature $23^\circ \pm 3^\circ \text{C}$, with $< 1^\circ \text{C}$ deviation from calibration temperature

Table 2a. N5227A with 85058B Calibration Kit

Description	Specification (dB)							
	10 MHz to 50 MHz	50 MHz to 2 GHz	2 GHz to 10 GHz	10 GHz to 20 GHz	20 GHz to 35 GHz	35 GHz to 50 GHz	50 GHz to 60 GHz	60 GHz to 67 GHz
Directivity	35	35	41	38	37	37	34	34
Source Match	34	34	44	40	41	42	40	40
Load Match	35	35	41	38	36	37	33	33
Reflection Tracking								
Mag	0.019	0.019	0.010	0.033	0.033	0.020	0.030	0.030
Phase (degree)	0.125	0.125	0.066	0.218	0.218	0.132	0.198	0.198
Transmission Tracking								
Mag	0.036	0.033	0.016	0.037	0.058	0.058	0.093	0.100
Phase (degree)	0.234	0.219	0.108	0.242	0.381	0.383	0.612	0.658

Transmission Uncertainty

Magnitude

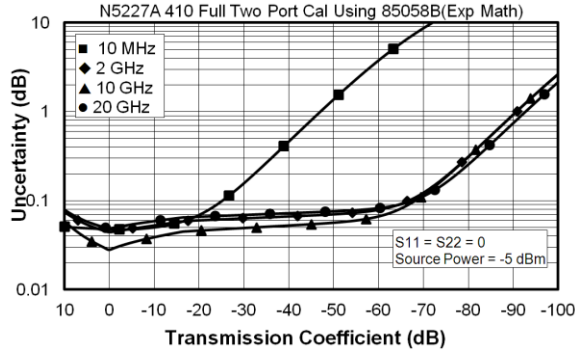

Phase

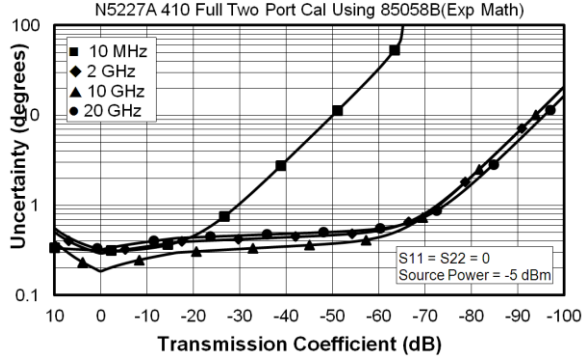

Magnitude

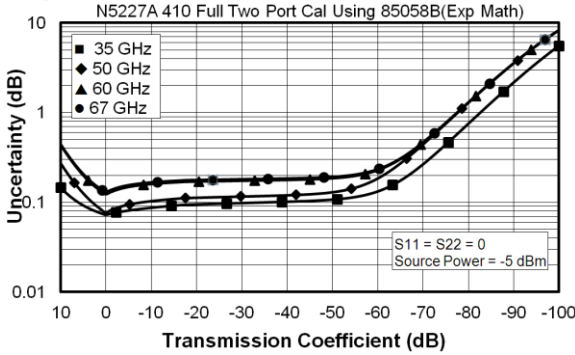

Phase

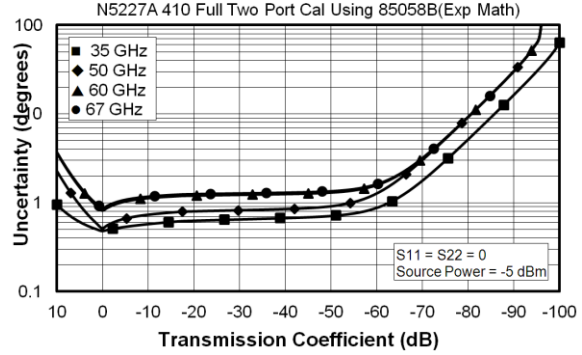

Reflection Uncertainty

Magnitude

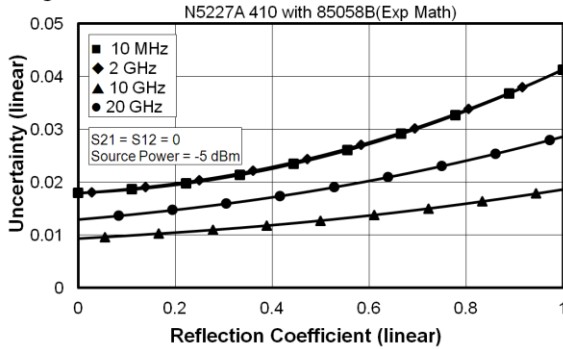

Phase

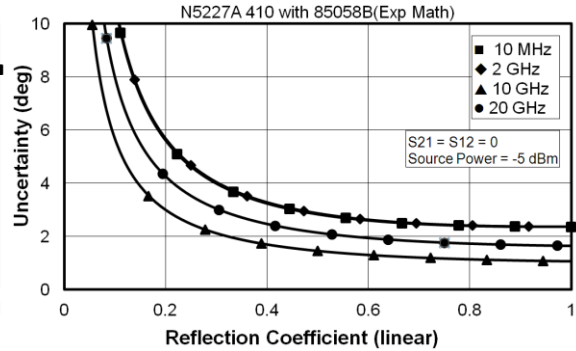

Magnitude

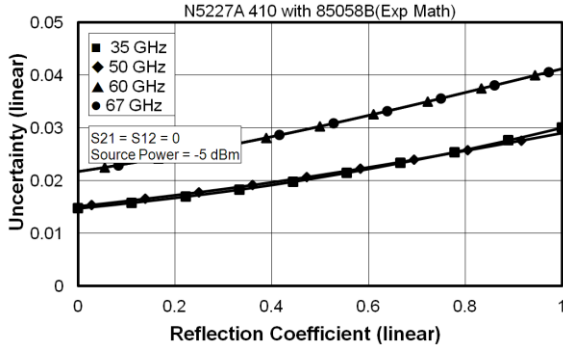

Phase

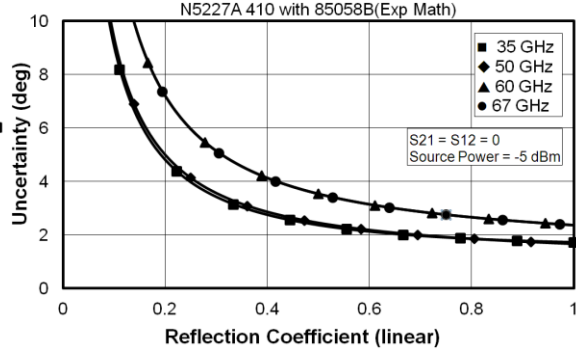
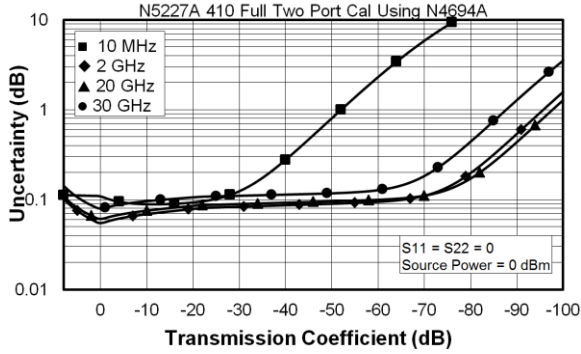

Table 2b. N5227A with N4694A 2-Port Electronic Calibration Module

Description	Specification (dB)							
	10 MHz to 50 MHz	50 MHz to 2 GHz	2 GHz to 20 GHz	20 GHz to 30 GHz	30 GHz to 40 GHz	40 GHz to 50 GHz	50 GHz to 60 GHz	60 GHz to 67 GHz
Directivity	33	41	47	46	44	42	41	38
Source Match	25	38	39	35	34	33	30	27
Load Match	25	38	38	34	33	32	29	26
Reflection Tracking								
Mag	±0.050	±0.040	±0.040	±0.050	±0.060	±0.070	±0.080	±0.090
Phase (degree)	±0.330	±0.264	±0.264	±0.330	±0.396	±0.462	±0.528	±0.594
Transmission Tracking								
Mag	±0.074	±0.045	±0.049	±0.064	±0.077	±0.092	±0.110	±0.133
Phase (degree)	±0.490	±0.296	±0.321	±0.420	±0.509	±0.605	±0.729	±0.878

Transmission Uncertainty

Magnitude



Phase

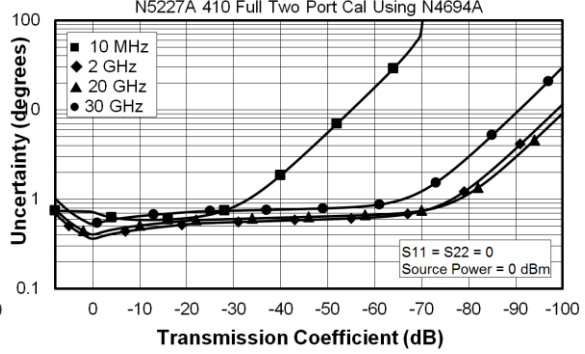

Magnitude

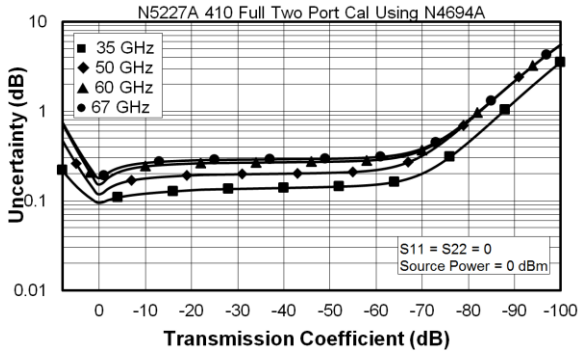

Phase

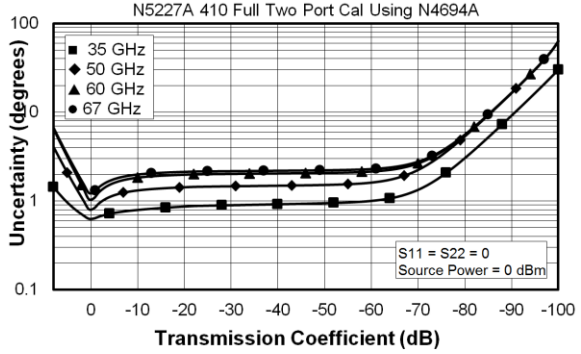

Reflection Uncertainty

Magnitude

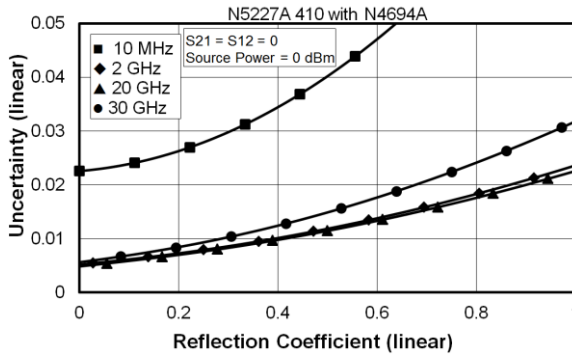

Phase

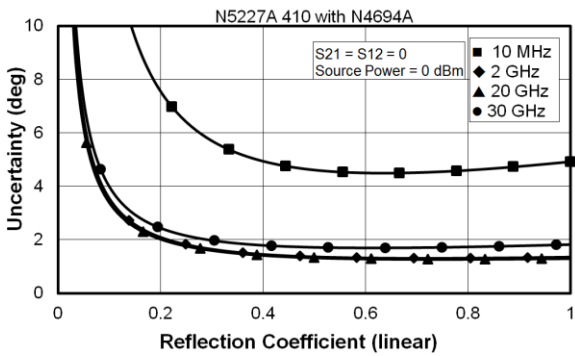

Magnitude

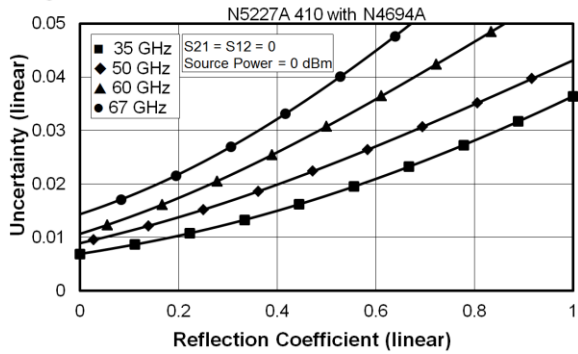

Phase

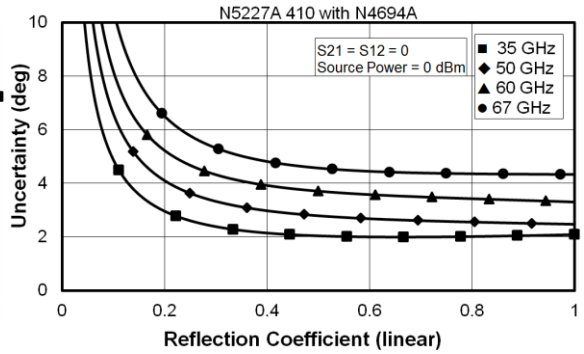

Uncorrected System Performance

Specifications apply to following conditions:

- Over environmental temperature of 25 °C ±5 °C, with less than 1°C variation from the calibration temperature.
- Cable loss not included in Transmission Tracking.
- Crosstalk measurement conditions: normalized to a thru, measured with shorts on all ports, 10 Hz IF bandwidth, averaging factor of 8, alternate mode, source power set to the specified maximum power.

Table 3a. Error Terms (dB), All Ports, Option 210, 410 - Specifications

	Directivity	Source Match	Load Match	Transmission Tracking	Reflection Tracking	Crosstalk
10 MHz to 50 MHz	17	21	18	--	--	--
50 MHz to 200 MHz	24	30	24	--	--	--
200 MHz to 500 MHz	24	29	23			
500 MHz to 2 GHz	24	21	19	--	--	--
2 GHz to 3.2 GHz	20	21	19			
3.2 GHz to 10 GHz	20	19	17	--	--	--
10 GHz to 13.5 GHz	16	19	15	--	--	--
13.5 GHz to 16 GHz	16	19	13			
16 GHz to 20 GHz	16	16	13	--	--	--
20 GHz to 24 GHz	14	14	12			
24 GHz to 26.5 GHz	14	13	12			
26.5 GHz to 43.5 GHz	13	12	10	--	--	--
43.5 GHz to 46 GHz	13	11	10			
46 GHz to 50 GHz	13	11	10			
50 GHz to 60 GHz	13	10	8	--	--	--
60 GHz to 67 GHz	10	9	8	--	--	--
67 GHz to 70 GHz	--	--	--	--	--	--

Table 3b. Error Terms (dB), All Ports, Option 210, 410 - Typical

	Directivity	Source Match	Load Match	Transmission Tracking	Reflection Tracking	Crosstalk
10 MHz to 50 MHz	20	29	25	+/- 1.0	+/- 1.0	-90
50 MHz to 200 MHz	28	38	32	+/- 1.0	+/- 1.0	-109

200 MHz to 500 MHz	28	35	31	+/- 1.0	+/- 1.0	-123
500 MHz to 2 GHz	31	27	25	+/- 1.0	+/- 1.0	-124
2 GHz to 3.2 GHz	28	27	25	+/- 1.0	+/- 1.0	-124
3.2 GHz to 10 GHz	25	24	23	+/- 1.0	+/- 1.0	-124
10 GHz to 13.5 GHz	23	25	21	+/- 1.0	+/- 1.0	-124
13.5 GHz to 16 GHz	23	26	21	+/- 1.0	+/- 1.0	-124
16 GHz to 20 GHz	20	21	19	+/- 1.0	+/- 1.0	-124
20 GHz to 24 GHz	18	19	18	+/- 1.0	+/- 1.0	-124
24 GHz to 26.5 GHz	18	19	17	+/- 1.0	+/- 1.0	-124
26.5 GHz to 43.5 GHz	16	17	16	+/- 1.0	+/- 1.0	-115
43.5 GHz to 46 GHz	19	16	15	+/- 1.0	+/- 1.0	-113
46 GHz to 50 GHz	19	16	16	+/- 1.0	+/- 1.0	-113
50 GHz to 60 GHz	16	14	14	+/- 1.0	+/- 1.0	-113
60 GHz to 67 GHz	16	13	14	+/- 1.0	+/- 1.0	-113
67 GHz to 70 GHz	15	11	11	+/- 1.0	+/- 1.5	-110

Test Port Output

Table 4. Frequency Information, Option 210, 410

Description	Specification	Typical
N5227A Frequency Range	10 MHz to 67 GHz	67 GHz to 70 GHz
Frequency Resolution	1 Hz	--
Frequency Accuracy	+/- 1 ppm	--
Frequency Stability	--	+/-0.05 ppm, -10° to 70° C ¹ +/-0.1 ppm/yr maximum ²

¹ Assumes no variation in time.

² Assumes no variation in temperature.

Table 5. Maximum Leveled Power (dBm) - Option 210, 410

Description	Specification		Typical	
	Port 1, Port 3	Port 2, Port 4	Port 1, Port 3	Port 2, Port 4
10 MHz to 50 MHz	6	6	14	11
50 MHz to 500 MHz	7	7	14	12
500 MHz to 1 GHz	7	7	14	15
1 GHz to 2 GHz	7	7	12	14
2 GHz to 3.2 GHz	4	7	11	12
3.2 GHz to 10 GHz	7	7	13	13
10 GHz to 13.5 GHz	6	6	12	10
13.5 GHz to 16 GHz	6	6	13	12
16 GHz to 19 GHz	5	5	11	11
19 GHz to 20 GHz	5	5	11	11
20 GHz to 24 GHz	5	5	10	10
24 GHz to 26.5 GHz	5	5	9	9
26.5 GHz to 30 GHz	4	4	9	9
30 GHz to 32 GHz	3	3	8	8
32 GHz to 35 GHz	4	4	9	9
35 GHz to 40 GHz	-1	-1	7	7
40 GHz to 43.5 GHz	5	5	6	6
43.5 GHz to 50 GHz	5	5	6	7
50 GHz to 60 GHz	5	5	6	7
60 GHz to 64 GHz	5	5	6	7
64 GHz to 67 GHz	5	5	7	8
67 GHz to 70 GHz	--	--	7	8

Table 6. Power Level Accuracy (dB), Option 210, 410

Description	Specification	Typical
10 MHz to 50 MHz	+/- 1.2	+/- 0.4
50 MHz to 1 GHz	+/- 1.0	+/- 0.4
1 GHz to 3.2 GHz	+/- 1.0	+/- 0.2
3.2 GHz to 20 GHz	+/- 2.0	+/- 0.4
20 GHz to 26.5 GHz	+/- 2.2	+/- 0.4
26.5 GHz to 40 GHz	+/- 3.0	+/- 0.5
40 GHz to 43.5 GHz	+/- 3.0	+/- 0.3
43.5 GHz to 50 GHz	+/- 3.0	+/- 0.5
50 GHz to 60 GHz	+/- 3.5	+/- 0.6
60 GHz to 67 GHz	+/- 4.0	+/- 0.7
67 GHz to 70 GHz	--	+/- 1.0

Table 7a. Power Level Linearity (dB), Option 210, 410 - Specification

Description	Specification		
	Port 1 or 3 ¹ -25dBm ≤ P < -20dBm	Port 1 or 3 ¹ -20dBm ≤ P < -15dBm	Port 1 or 3 ¹ P ≥ -15dBm
10 MHz to 50 MHz	+/-2.5	+/-1.5	+/-1.5
MHz to 67 GHz	+/-1.5	+/-1.5	+/-1.5

¹ Either port can be used as the source port.

Table 7b. Power Level Linearity (dB), Option 210, 410 - Specification

Description	Specification		
	Port 2 or 4 ¹ -25dBm ≤ P < -20dBm	Port 2 or 4 ¹ -20dBm ≤ P < -15dBm	Port 2 or 4 ¹ P ≥ -15dBm
10 MHz to 50 MHz	+/-3.5	+/-1.5	+/-1.5
50 MHz to 500 MHz	+/-2.5	+/-1.5	+/-1.5
500 MHz to 3.2 GHz	+/-2.5	+/-1.5	+/-1.5

3.2 GHz to 67 GHz	+/-1.5	+/-1.5	+/-1.5
-------------------	--------	--------	--------

¹ Either port can be used as the source port.

Table 8. Power Sweep Range (dB) – Option 210, 410

Description	Specification		Typical	
	Port 1, Port 3	Port 2, Port 4	Port 1, Port 3	Port 2, Port 4
10 MHz to 50 MHz	31	31	41	38
50 MHz to 500 MHz	32	32	41	39
500 MHz to 1 GHz	32	32	41	42
1 GHz to 2 GHz	32	32	39	41
2 GHz to 3.2 GHz	29	32	38	39
3.2 GHz to 10 GHz	32	32	40	40
10 GHz to 13.5 GHz	31	31	39	37
13.5 GHz to 16 GHz	31	31	40	39
16 GHz to 20 GHz	30	30	38	38
20 GHz to 24 GHz	30	30	37	37
24 GHz to 26.5 GHz	30	30	36	36
26.5 GHz to 30 GHz	29	29	36	36
30 GHz to 32 GHz	28	28	35	35
32 GHz to 35 GHz	29	29	36	36
35 GHz to 40 GHz	24	24	34	34
40 GHz to 43.5 GHz	30	30	33	33
43.5 GHz to 64 GHz	30	30	33	34
64 GHz to 67 GHz	30	30	34	35
67 GHz to 70 GHz	--	--	34	35

Table 9. Nominal (Preset) Power (dBm)

Description	Option 210, 410
Preset Power	-5

Table 10. Power Resolution and Maximum/Minimum Settable Power, Option 210, 410

Description	Specification (dB)	Typical (dBm)
Power Resolution	0.01	--
Maximum Settable Power	--	30
Minimum Settable Power	--	-30

Table 11. 2nd and 3rd Harmonics at Max Specified Power (dBc), Option 210, 410

Listed frequency is harmonic frequency; test at max specified power

Description	Typical
20 MHz to 4 GHz	-17
3Hz to 24 GHz	-20
24 GHz to 27 GHz	-21
27 GHz to 40.5 GHz	-32
40.5 GHz to 67 GHz	-60
67 GHz to 70 GHz	-60

Table 12. Non-Harmonic Spurs at Nominal Power (dBc), Option 210, 410 - Typical

Description	Based on 8kHz offset Frac-N	Based on 100kHz offset Frac-N
10 MHz to 500 MHz	-50	-50
500 MHz to 2 GHz	-60	-42
2 GHz to 4 GHz	-57	-45
4 GHz to 8 GHz	-51	-39
8 GHz to 16 GHz	-45	-33
16 GHz to 32 GHz	-39	-27
32 GHz to 64 GHz	-33	-21
64 GHz to 70 GHz	-27	-15

Table 13. Phase Noise (dBc/Hz), Option 210, 410 - Typical

Description	1 kHz Offset	10 kHz Offset	100 kHz Offset	1 MHz Offset
10 MHz to 50 MHz	-100	-95	-95	-120
50 MHz to 1 GHz	-107	-117	-112	-127
1 GHz to 2 GHz	-101	-111	-106	-121
2 GHz to 4 GHz	-95	-105	-100	-115
4 GHz to 8 GHz	-89	-99	-94	-109
8 GHz to 16 GHz	-83	-93	-88	-103
16 GHz to 32 GHz	-77	-87	-82	-97
32 GHz to 64 GHz	-71	-81	-76	-91
64 GHz to 70 GHz	-65	-75	-70	-85

Test Port Input

Table 14. Test Port Noise Floor (dBm) @ 10 Hz IFBW, Option 210, 410

Total average (rms) noise power calculated as the mean value of a linear magnitude trace expressed in dBm. May typically be degraded at particular frequencies below 500 MHz due to spurious receiver residuals.

Description	Specification	Typical
10 MHz to 50 MHz	-70	-76
50 MHz to 100 MHz	-92	-97
100 MHz to 500 MHz	-101	-106
500 MHz to 1 GHz	-110	-115
1 GHz to 10 GHz	-114	-119
10 GHz to 13.5 GHz	-114	-120
13.5 GHz to 24 GHz	-116	-121
24 GHz to 26.5 GHz	-117	-121
26.5 GHz to 35 GHz	-106	-112

35 GHz to 40 GHz	-104	-110
40 GHz to 50 GHz	-101	-108
50 GHz to 60 GHz	-101	-107
60 GHz to 67 GHz	-101	-108
67 GHz to 70 GHz	--	-106

Table 15. 0.1 dB Receiver Compression at Test Port (dBm), Option 210, 410

Description	Typical
10 MHz to 100 MHz	15
100 MHz to 30 GHz	12
30 GHz to 67 GHz	11

Table 16. Receiver Compression at Test Port Power - Specification

Description	Test Port Power (dBm)	Receiver Compression	
	Option 210, 410	Magnitude (dB)	Phase (degrees)
10 MHz to 500 MHz ¹	--	--	--
500 MHz to 16 GHz	8	0.08	0.55
16 GHz to 20 GHz	8	0.08	0.60
20 GHz to 26.5 GHz	8	0.09	0.60
26.5 GHz to 30 GHz	8	0.10	0.75
30 GHz to 35 GHz	5	0.10	0.65
35 GHz to 40 GHz	3	0.13	0.70
40 GHz to 43.5 GHz	2	0.13	0.70
43.5 GHz to 50 GHz	2	0.13	0.8
50 GHz to 67 GHz	0	0.13	1.0

¹Test port receiver compression at specified input levels below 500 MHz due to coupler roll off in this frequency range.

Table 17. N5227A Trace Noise Magnitude (dB rms)

Ratioed measurement, nominal power at test port.

Description	Specification	Typical		
	1 kHz IFBW	1 kHz IFBW	100 kHz IFBW	600 kHz IFBW
10 MHz to 50 MHz	0.05	0.0177	0.173	0.416
50 MHz to 100 MHz	0.004	0.0012	0.012	0.029
100 MHz to 500 MHz	0.002	0.0006	0.006	0.014
500 MHz to 1 GHz	0.002	0.0004	0.003	0.006
1 GHz to 26.5 GHz	0.002	0.0005	0.002	0.005
26.5 GHz to 50 GHz	0.003	0.0006	0.005	0.012
50 GHz to 67 GHz	0.003	0.0007	0.006	0.013
67 GHz to 70 GHz	--	0.0010	0.007	0.016

Table 18. N5227A Trace Noise Phase (deg rms)

Ratioed measurement, nominal power at test port.

Description	Specification	Typical		
	1 kHz IFBW	1 kHz IFBW	100 kHz IFBW	600 kHz IFBW
10 MHz to 50 MHz	0.400	0.1228	1.205	2.928
50 MHz to 100 MHz	0.020	0.0083	0.080	0.196
100 MHz to 500 MHz	0.020	0.0040	0.037	0.097
500 MHz to 1 GHz	0.020	0.0017	0.015	0.037
1 GHz to 26.5 GHz	0.020	0.0075	0.015	0.031
26.5 GHz to 43.5 GHz	0.030	0.0125	0.040	0.091
43.5 GHz to 50 GHz	0.035	0.0149	0.040	0.092
50 GHz to 67 GHz	0.045	0.0200	0.048	0.110
67 GHz to 70 GHz	--	0.0213	0.050	0.119

Table 19. Reference Level Magnitude, Option 210, 410 - Specification

Description	Magnitude (dB)	Phase (degrees)
Range	+/- 500	+/- 500
Resolution	0.001	0.01

Table 20. Stability vs. Temperature, Option 210, 410 - Typical

Description	Magnitude (dB/°C)	Phase (°/°C)
10 MHz to 50 MHz	0.03	0.400
50 MHz to 3.2 GHz	0.01	0.100
3.2 GHz to 20 GHz	0.01	0.200
20 GHz to 32 GHz	0.01	0.300
32 GHz to 35 GHz	0.02	0.400
35 GHz to 50 GHz	0.02	0.400
50 GHz to 67 GHz	0.03	0.600
67 GHz to 70 GHz	0.06	1.200

Table 21. Stability vs. Time, Option 210, 410 - Specification

The specifications below are observations of the maximum drift performance over +/- 0.5 °C and a period of 24 hours subsequent to a 48 hours warm up period, with ideal load for reflections and ideal thru for transmission measurements.

Description	Magnitude (dB/24 hours)		
	S11, S22, S33, S44	S21, S12, S43, S34	S31, S13, S41, S14, S42, S24, S32, S23
10 MHz to 12 MHz ¹	-52	0.025	0.025
12 MHz to 500 MHz ¹	-60	0.013	0.018
500 MHz to 10 GHz	-65	0.010	0.014
10 GHz to 20 GHz	-65	0.017	0.024
20 GHz to 26.5 GHz	-65	0.024	0.034
26.5 GHz to 32 GHz	-60	0.028	0.040
32 GHz to 40 GHz	-60	0.036	0.051
40 GHz to 43.5 GHz	-60	0.037	0.052

43.5 GHz to 50 GHz	-60	0.043	0.061
50 GHz to 60 GHz	-60	0.055	0.078
60 GHz to 64 GHz	-60	0.055	0.080
64 GHz to 67 GHz	-60	0.061	0.086

¹ Performance may be degraded at frequencies below 500 MHz due to spurious receiver residuals.

Table 22. Damage Input Level, Option 210, 410

Description	RF (dBm)	DC (V)
N5227A	27	40

Dynamic Accuracy

Dynamic accuracy is verified with the following measurements:

Compression over frequency

IF linearity at a single frequency of 1.998765GHz using a reference level of -20 dBm for an input power range of 0 to -60 dBm. For values below -60 dBm, refer to [VNA Receiver Dynamic Accuracy Specifications and Uncertainties](#)

Table 23. N5227A Dynamic Accuracy

N5227A Dynamic Accuracy, 10 MHz - Specification

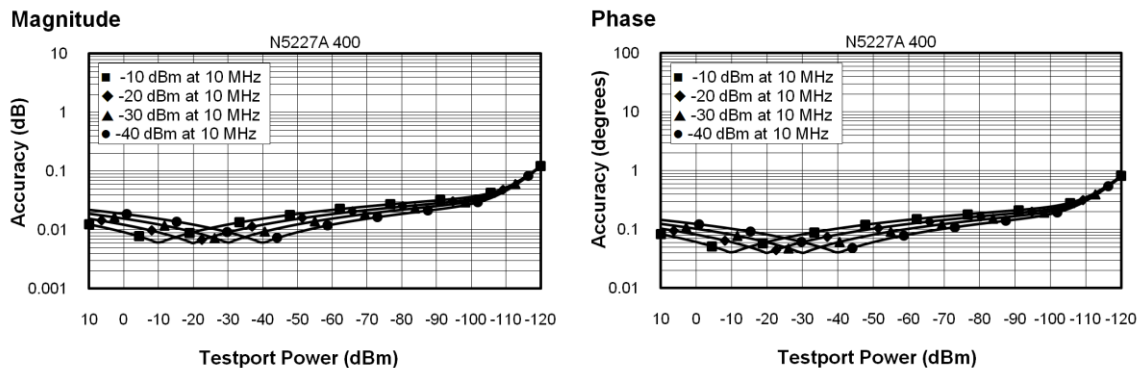

N5227A Dynamic Accuracy, 50 MHz - Specification

Magnitude

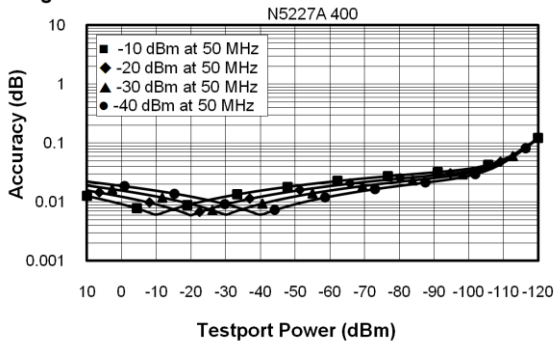

Phase

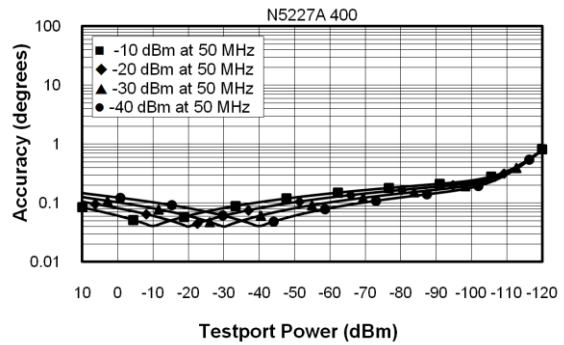

N5227A Dynamic Accuracy, 500 MHz - Specification

Magnitude

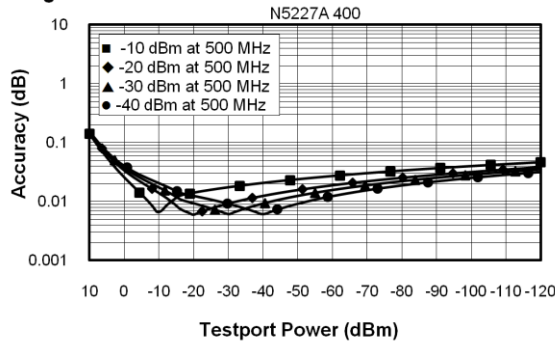

Phase

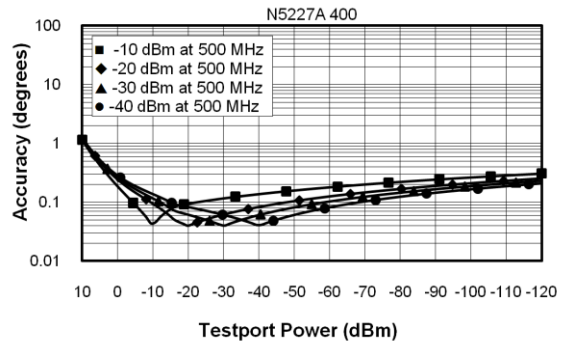

N5227A Dynamic Accuracy, 1 GHz - Specification

Magnitude

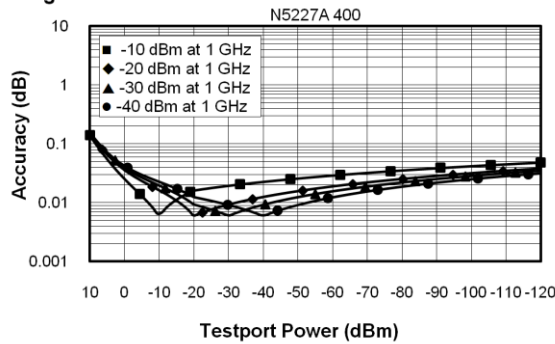

Phase

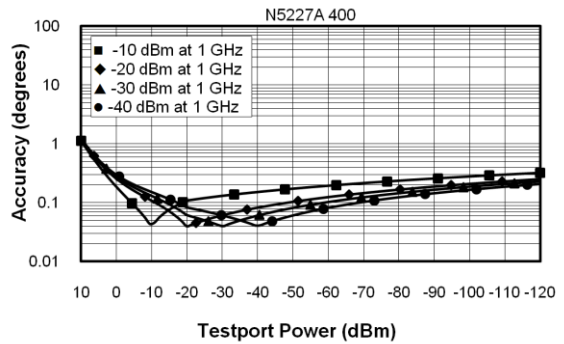

N5227A Dynamic Accuracy, 2 GHz - Specification

Magnitude

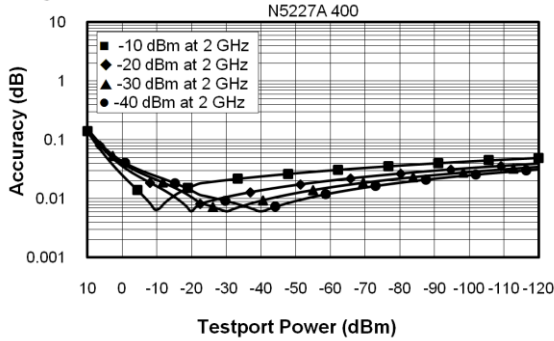

Phase

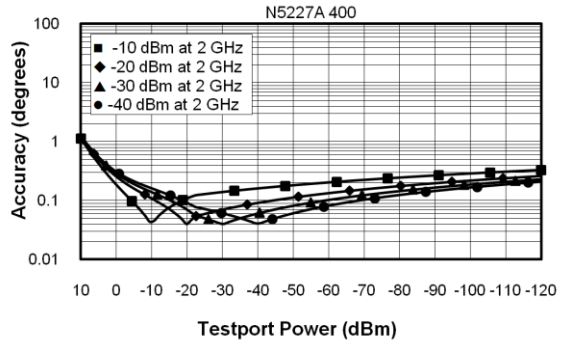

N5227A Dynamic Accuracy, 20 GHz - Specification

Magnitude

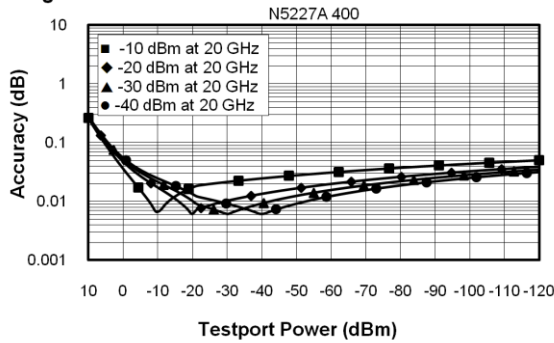

Phase

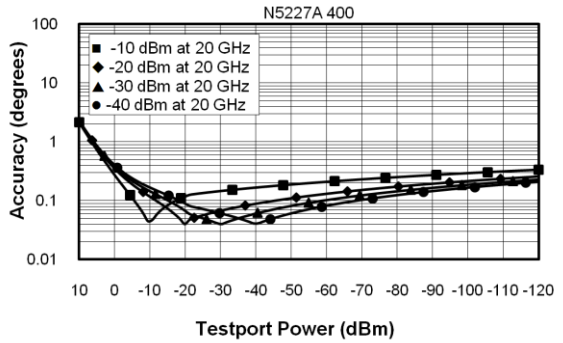

N5227A Dynamic Accuracy, 26.5 GHz - Specification

Magnitude

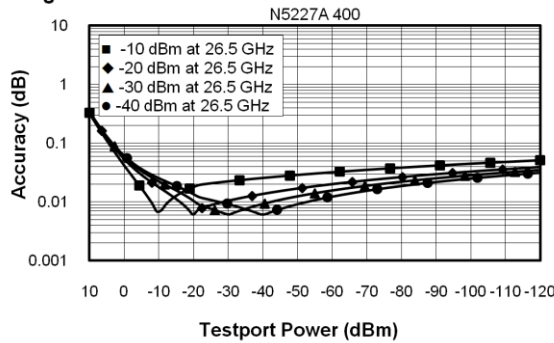

Phase

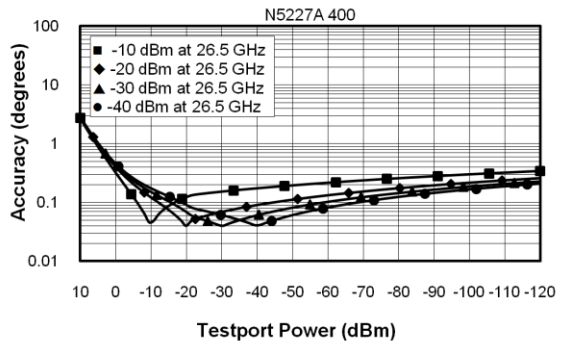

N5227A Dynamic Accuracy, 35 GHz - Specification

Magnitude

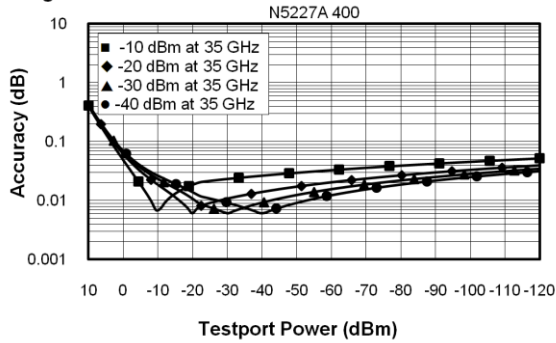

Phase

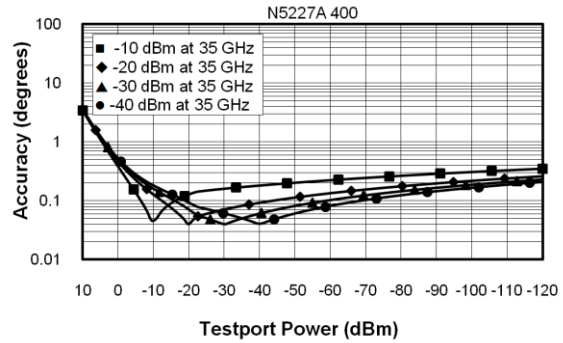

N5227A Dynamic Accuracy, 40 GHz - Specification

Magnitude

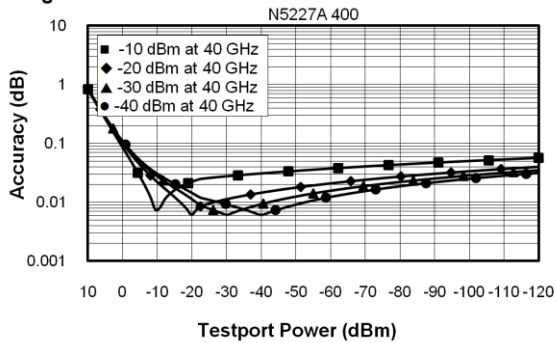

Phase

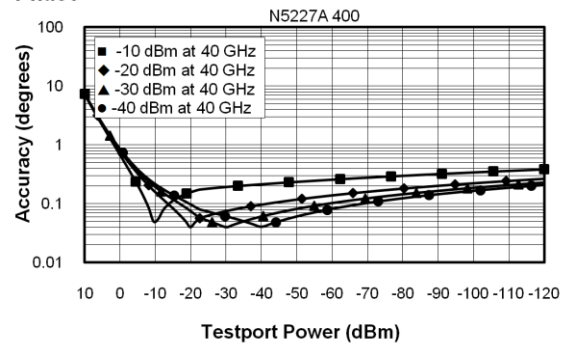

N5227A Dynamic Accuracy, 50 GHz - Specification

Magnitude

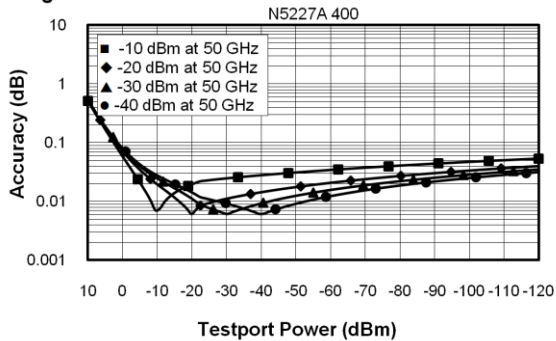

Phase

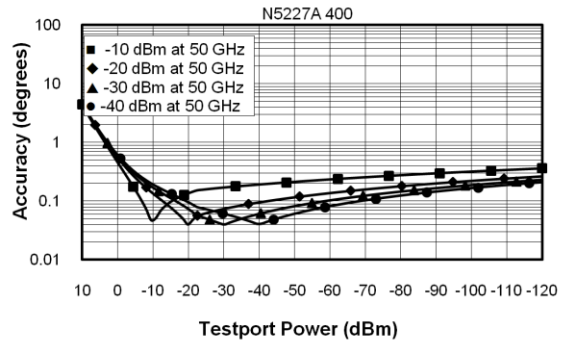

N5227A Dynamic Accuracy, 60 GHz - Specification

Magnitude

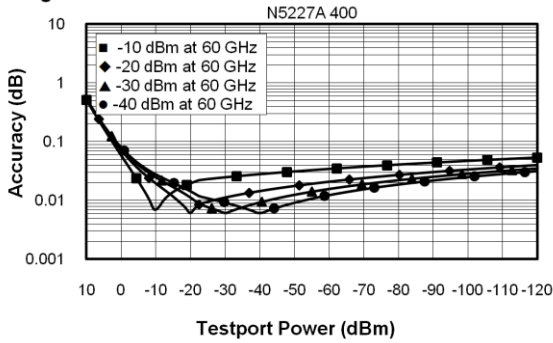

Phase

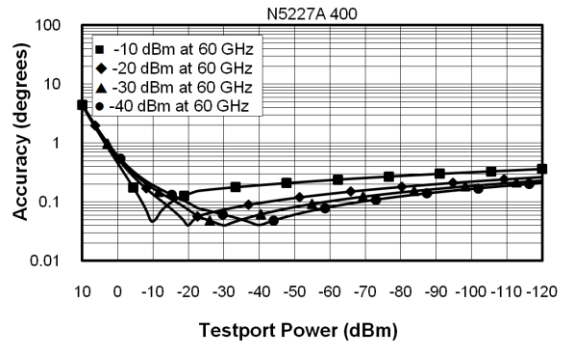

N5227A Dynamic Accuracy, 67 GHz - Specification

Magnitude

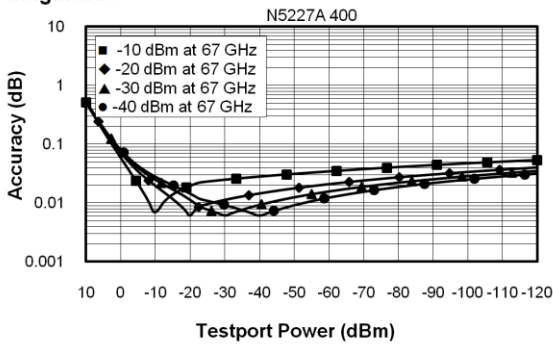

Phase

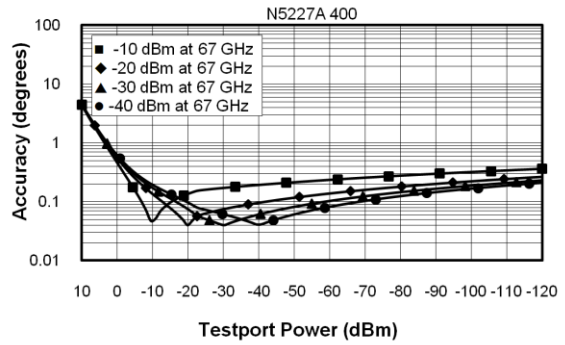

Table 24. Group Delay - Typical

Group delay is computed by measuring the phase change within a specified frequency step (determined by the frequency span and the number of points per sweep). In general, the following formula can be used to determine the accuracy, in seconds, of specific group delay measurement:

$$\pm \text{Phase Accuracy (deg)} / [360 \times \text{Aperture (Hz)}]$$

Depending on the aperture and device length, the phase accuracy used is either incremental phase accuracy or worst-case phase accuracy

Description	Typical Performance
Aperture (selectable)	(frequency span)/(number of points -1)
Maximum Aperture	20% of frequency span
Range	0.5 x (1/minimum aperture)
Maximum Delay	Limited to measuring no more than 180° of phase change within the minimum aperture.)

The following graph shows characteristic group delay accuracy with full 2-port calibration and a 10 Hz IF bandwidth. Insertion loss is assumed to be < 2 dB and electrical length to be ten meters.

For any S_{ij} Group Delay measurement, $S_{ii} = 0$, $S_{ij} = 1$, $S_{ji} = 0$, $S_{kl} = 0$ for all $kl \neq ij$

Group Delay (Typical)

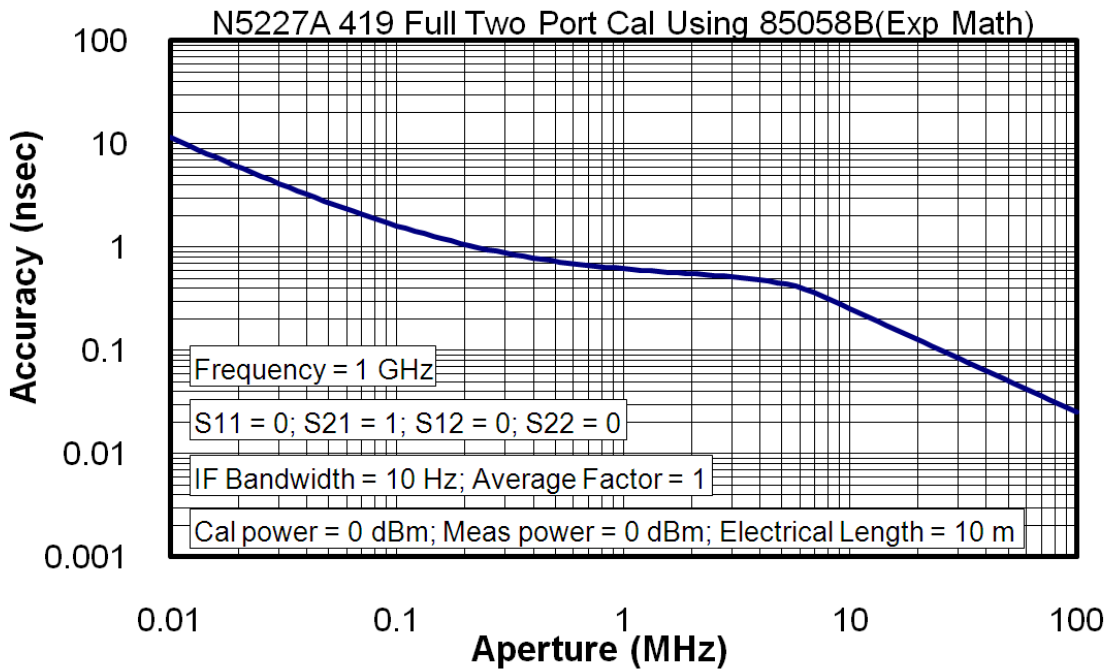

General Information

- [Miscellaneous Information](#)
- [Front Panel](#)
- [Rear Panel](#)
- [Environment and Dimensions](#)

Table 25. Miscellaneous Information

Description	Supplemental Information
System IF Bandwidth Range	1 Hz to 15 MHz, nominal
CPU	Intel 2.0 GHz Core i7 Note: Some instruments may have a different CPU. For the latest information on CPUs and associated hard drives, visit: http://na.support.keysight.com/pna/hdnumbers.html
LXI	Class C

Table 26. Front Panel Information, Option 210, 410

Description	Typical Performance
RF Connectors	
Type	1.85 mm (male), 50 ohm, (nominal)
Center Pin Recession	0.002 in. (characteristic)
USB 2.0 Ports - Master (4 ports)	
Standard	Compatible with USB 2.0
Connector	USB Type-A female
Display	
Size	26.3 cm (10.4 in) diagonal color active matrix LCD; 1024 (horizontal) X 768 (vertical) resolution
Refresh Rate	Vertical 60 Hz; Horizontal 46.08 kHz
Pixels	Any of the following would cause a display to be considered faulty: <ul style="list-style-type: none"> · A complete row or column consists of “stuck” or “dark” pixels. · More than six “stuck on” pixels (but not more than three green) or more than 0.002% of the total pixels are within the LCD specifications. · More than twelve “dark” pixels (but no more than seven of the same color) or more than 0.004% of the total pixels are within the LCD specifications. · Two or more consecutive “stuck on” pixels or three or more consecutive “dark” pixel (but no more than one set of two consecutive dark pixels) · “Stuck on” “dark” pixels are less than 6.5 mm apart (excluding consecutive pixels)

Table 26. (Continued) Front Panel Information, Option 210, 410

Description	Typical Performance
Display Range	
Magnitude	+/-2500 dB (at 500 dB/div), max
Phase	+/-2500° (at 500 dB/div), max
Polar	10 pUnits, min 10,000 Units, max
Display Resolution	
Magnitude	0.001 dB/div, min
Phase	0.01°/div, min
Marker Resolution	
Magnitude	0.001 dB, min
Phase	0.01°, min
Polar	10 pUnit, min

Table 27. Rear Panel Information, Option 210, 410

Description	Typical Performance
10 MHz Reference In	
Connector	BNC, female
Input Frequency	10 MHz \pm 10 ppm
Input Level	-15 dBm to +20 dBm
Input Impedance	200 Ω , nom.
10 MHz Reference Out	
Connector	BNC, female
Output Frequency	10 MHz \pm 1 ppm
Signal Type	Sine Wave
Output Level	+10 dBm \pm 4 dB into 50 Ω
Output Impedance	50 Ω , nominal
Harmonics	<-40 dBc, typical

Table 27. (Continued) Rear Panel Information, Option 210, 410

Description	Typical Performance
External IF Inputs	
Function	Allows use of external IF signals from remote mixers, bypassing the PNA's first converters
Connectors	SMA (female); A, B, C, D, R (4-port); A, B, R1, R2 (2-port)
Input Frequency	
Normal IF path	RF < 53 MHz: IF = 826.446 KHz RF >= 53 MHz: IF = 7.438 MHz
Narrowband IF path	IF = 10.70 MHz
Input Impedance	50 Ω
RF Damage Level	+23 dBm
DC Damage Level	5.5 VDC
0.1 dB Compression Point	
Normal IF path	-9.0 dBm at 7.438 MHz
Narrowband IF path	-17 dBm at 10.70 MHz
Pulse Inputs (IF Gates)	
Function	Internal receiver gates used for point-in-pulse and pulse-profile measurements
Connectors	15-pin mini D-sub
Input Impedance	1 K Ohm
Minimum Pulse Width, Source Modulators	33 ns
Minimum Pulse Width, Receiver Gates	20 ns
DC Damage Level	5.5 VDC
Drive Voltage	0 V (off), +3.3 V (on), nominal
RF Pulse Modulator Input (Source Modulator)	
On/Off Ratio	
10 MHz to 3.2 GHz	-64
3.2 GHz to 67 GHz	-80
Pulse Period	
Minimum	33 ns
Maximum	70 s

Table 27. (Continued) Rear Panel Information, Option 210, 410

Description	Typical Performance	
Pulse Outputs		
Voltage (TTL)	High: 3.3V to 3.5V Low: <1V	
Impedance	50 Ohm	
External Test Set Driver		
Function	Used for driving remote mixers	
Connections	3.5 mm (female)	
RF Output Frequency Range	3.2 GHz to 19 GHz	
LO Output Frequency Range	1.76 GHz to 26.5 GHz	
Rear Panel LO Power¹		
	Upper Limit, Typical (dBm)	Lower Limit, Typical (dBm)
1.7 GHz to 16 GHz	5	-3
16 GHz to 21 GHz	0	-6
21 GHz to 26.5 GHz	4	-5
Rear Panel RF1/RF2 Power		
	Maximum Output Power, Typical (dBm)	
3.2 GHz to 5 GHz	+3	
5 GHz to 19 GHz	+8	
VGA Video Output		
Connector	15-pin mini D-Sub; Drives VGA compatible monitors	
Devices Supported		
Resolutions		
Flat Panel (TFT)	1024 X 768, 800 X 600, 640 X 480	
Flat Panel (DSTN)	800 X 600, 640 X 480	
CRT Monitor	1280 X 1024, 1024 X 768, 800 X 600, 640 X 480	
Simultaneous operation of the internal and external displays is allowed, but with 640 X 480 resolution only. If you change resolution, you can only view the external display (internal display will "white out").		

¹ LO output available in full analyzer's frequency range. The power is tested only from 3.2 GHz to 26.5 GHz.

Table 27. (Continued) Rear Panel Information, Option 210, 410

Description	Typical Performance
Trigger Inputs/Outputs	BNC(f), TTL/CMOS compatible
Test Set IO	25-pin D-Sub connector, available for external test set control.
Power IO	9-pin D-Sub, female; analog and digital IO
Handler IO	36-pin parallel I/O port; all input/output signals are default set to negative logic; can be reset to positive logic via GPIB command.
GPIB	Two ports - dedicated controller and dedicated talker/listener. 24-pin D-sub (Type D-24), female; compatible with IEEE-488.
Parallel Port (LPT1)	25-pin D-Sub miniature connector, female; provides connection to printers or any other parallel port peripherals
USB Ports	Four ports on front panel (all Host) and five ports (four Host and one Device) on rear panel. Type A configuration (eight Host) and Type B configuration (one Device), USB 2.0 compatible. The total current limit for all rear panel USB ports is 2.0 amps. The total current limit for all front panel USB is 0.9 amps.
LAN	10/100BaseT Ethernet, 8-pin configuration; auto selects between the two data rates
Line Power	
Frequency, Voltage	50/60/400 Hz for 100 to 120 VAC
	50/60 Hz for 220 to 240 VAC
	Power supply is auto switching
Max	450 watts

Table 28. Analyzer Dimensions and Weight

All models are shipped with handles.

Cabinet Dimensions	Metric (mm)	Imperial (inches)
Height		
Without bottom feet: ¹ EIA RU = 6	266.1	10.5
With bottom feet	279.1	11.0
Width		
Without handles or rack-mount flanges	425.6	16.8
With handles, without rack-mount flanges	458.7	18.1
With handles and rack-mount flanges	482.9	19.0
Depth		
Without front and rear panel hardware	582.3	22.9
With front and rear panel hardware, handles	649.6	25.6

¹Electronics Industry Association rack units. 1 RU = 1.75 in.

See detailed PNA dimension drawings at: <http://na.support.keysight.com/pna/PNADimensions.pdf>

Weight (nominal)	Net	Shipping
2-port models (Option 210)	42.2 kg (93 lb)	57.6 kg (127 lb)
4-port models (Option 410)	44.9 kg (99 lb)	60.3 kg (133 lb)

Regulatory and Environmental Information

For Regulatory and Environmental information, refer to the PNA Series Installation and Quick Start Guide, located online at <http://literature.cdn.keysight.com/litweb/pdf/E8356-90001.pdf>.

Measurement Throughput Summary

- Typical Cycle Time for Measurement Completion
- Cycle Time vs. IF Bandwidth
- Cycle Time vs. Number of Points
- Data Transfer Time

Cycle time Includes sweep time, retrace time and band-crossing time. Analyzer display turned off with DISPLAY:ENABLE OFF. Add 21 ms for display on. Data for one trace (S₁₁) measurement.

Table 29. Typical Cycle Time (ms) for Measurement Completion, All Models and Options

Sweep Range	IF Bandwidth	Number of Points					
		201	401	1601	16001	32001	
9 GHz to 10 GHz	600 kHz	Uncorrected	6.3	7	10.9	69.5	135
		2-Port cal	18.8	20.3	30.5	152	291
	10 kHz	Uncorrected	28.1	54.7	205	2003	4006
		2-Port cal	67.2	117	418	4028	8062
	1 kHz	Uncorrected	225	444	1744	17041	33853
		2-Port cal	463	900	3500	34100	67744
10 GHz to 20 GHz	600 kHz	Uncorrected	19.5	20.3	25.8	79.7	141
		2-Port cal	46.9	49.2	60.2	174	310
	10 kHz	Uncorrected	69.5	128	259	2012	4012
		2-Port cal	146	264	528	4041	8072
	1 kHz	Uncorrected	235	459	1783	17384	34538
		2-Port cal	477	924	3575	34788	69103

Table 30. Typical Cycle Time (ms) for Full-Span Measurement Completion

10 MHz to 67 GHz		Number of Points				
IF Bandwidth		201	401	1601	16001	32001
600 kHz	Uncorrected	55.5	72.7	94.5	182	248
	2-Port cal	117	152	195	374	509
10 kHz	Uncorrected	89.1	153	519	2219	4223
	2-Port cal	185	313	1042	4448	8462
1 kHz	Uncorrected	255	483	1834	17716	35172
	2-Port cal	515	972	3675	35444	70375

Table 31. Cycle Time vs. IF Bandwidth - Typical

Applies to the Preset condition (201 points, correction off) except for the following changes:

- CF = 10 GHz
- Span = 100 MHz
- Display off (add 21 ms for display on)

Cycle time includes sweep and retrace time.

Description		N5227A	
IF Bandwidth (Hz)	Cycle Time (ms)	Trace Noise Magnitude (dB rms)	
600,000	6.3	0.0044	
100,000	7	0.0021	
30,000	10.2	0.0011	
10,000	29.7	0.0007	
3,000	71.9	0.0006	
1,000	223	0.0004	
300	641	0.0004	
100	1825	0.0003	
30	5981	0.0003	
10	17834	0.0003	
3	59273	0.0003	

Table 32. Cycle Time vs. Number of Points - Typical

Applies to the Preset condition (correction off) except for the following changes:

- CF = 10 GHz
- Span = 100 MHz
- Display off (add 21 ms for display on)

Cycle time includes sweep and retrace time.

Description	IF Bandwidth (Hz)			
	1,000	10,000	30,000	600,000
3	7.8	6.3	6.3	6.3
11	16.4	6.3	6.3	6.3
51	60	11	6.3	6.3
101	114	17.2	7	6.3
201	223	29.7	9.4	6.3
401	437	54.7	14.9	7.1
801	862	105	25	7.8
1,601	1708	205	46	11
6,401	6728	805	169	30.5
16,001	16672	2005	417	68.8
32,001	33112	4006	833	134

Table 33. Data Transfer Time (ms) - Typical

Measured with the analyzer display off.

Values will increase slightly if the analyzer display is on.

Description	Number of Points				
	201	401	1601	16,001	32,001
SCPI over GPIB (Program executed on external PC ²)					
32-bit floating point	4.6	9.3	38	352	720
64-bit floating point	9.4	18.8	73.4	730	1455
ASCII	36.7	72.5	288	2882	5762
SCPI over SICL/LAN or TCP/IP Socket¹ (Program executed in the analyzer)					
32-bit floating point	<1	<1	<1	1.2	2.4
64-bit floating point	<1	<1	<1	2.3	4.6
ASCII	2.1	4	15	148	295
COM¹ (Program executed in the analyzer)					
32-bit floating point	<1	<1	<1	<1	<1
Variant type	<1	<1	1.4	12.4	25.5
DCOM over LAN¹ (Program executed on external PC)					
32-bit floating point	<1	<1	<1	2.3	4.4
Variant type	<1	1.6	5.3	52	105.5

¹ Values are for real and imaginary pairs, with the analyzer display off, using Gigabit Ethernet.

Note: Specifications for Recall & Sweep Speed are not provided for the N522xA analyzers.

Test Set Block Diagrams

NOTE: For best readability, use a color printer for printing the following graphics.

Legend

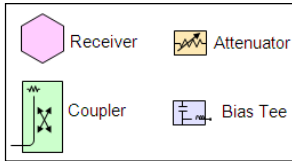

N5227A Option 210 (2-port metrology configuration)

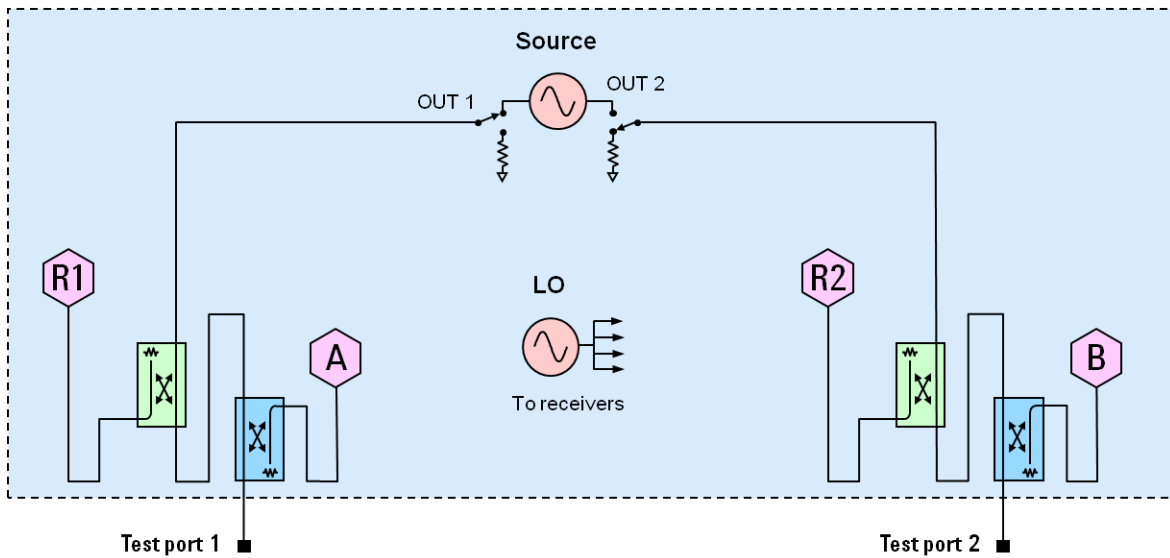

N5227A Option 410 (4-port metrology configuration)

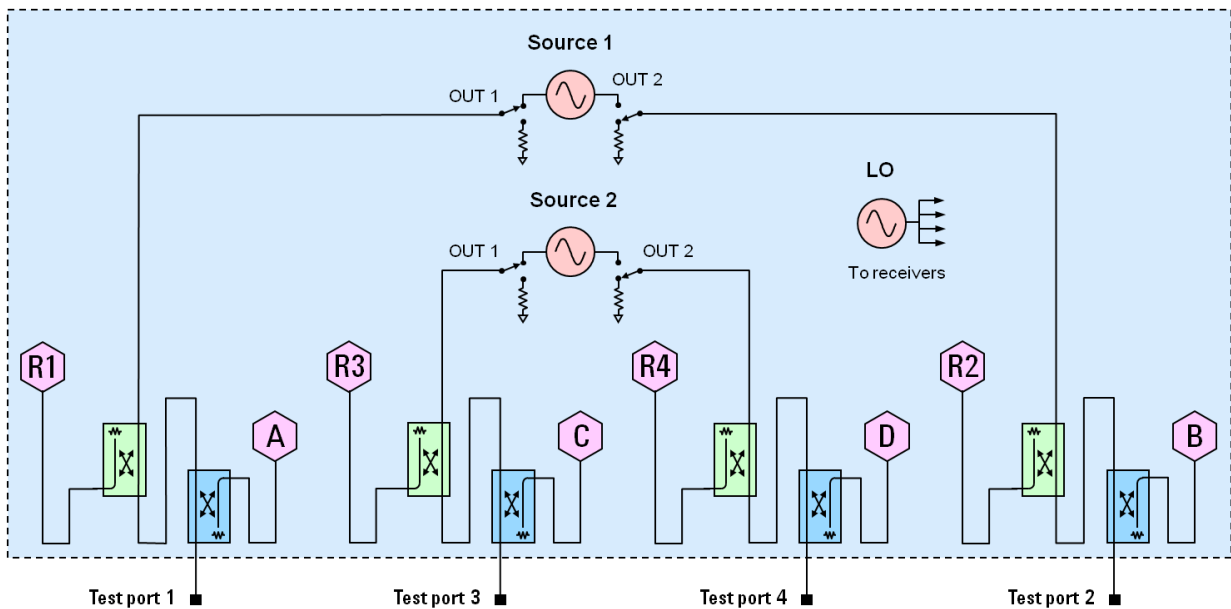

Receiver Block Diagram

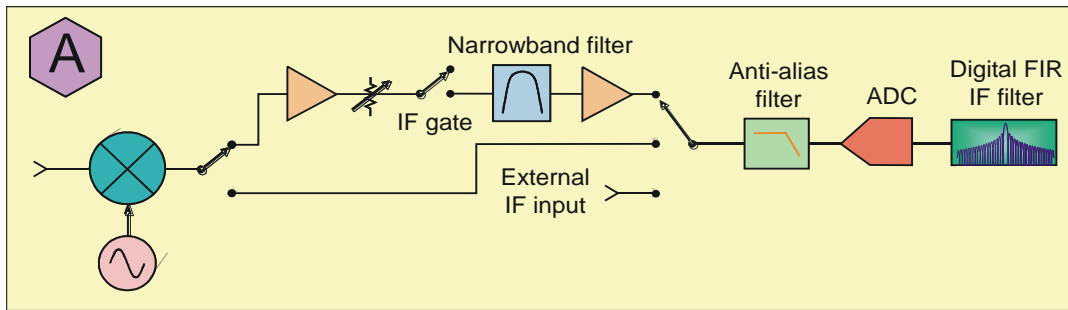

www.keysight.com/find/myKeysight

A personalized view into the information most relevant to you.



www.axistandard.org

AdvancedTCA® Extensions for Instrumentation and Test (AXIe) is an open standard that extends the AdvancedTCA for general purpose and semiconductor test. Keysight is a founding member of the AXIe consortium.



www.lxistandard.org

LAN eXtensions for Instruments puts the power of Ethernet and the Web inside your test systems. Keysight is a founding member of the LXI consortium.



www.pxisa.org

PCI eXtensions for Instrumentation (PXI) modular instrumentation delivers a rugged, PC-based high-performance measurement and automation system.



Three-Year Warranty

www.keysight.com/find/ThreeYearWarranty

Keysight's combination of product reliability and three-year warranty coverage is another way we help you achieve your business goals: increased confidence in uptime, reduced cost of ownership and greater convenience.



Keysight Assurance Plans

Keysight Advantage Services

www.keysight.com/find/AssurancePlans

Five years of protection and no budgetary surprises to ensure your instruments are operating to specifications and you can continually rely on accurate measurements



www.keysight.com/go/quality

Keysight Electronic Measurement Group
DEKRA Certified ISO 9001:2008
Quality Management System

Keysight Channel Partners

www.keysight.com/find/channelpartners

Get the best of both worlds: Keysight's measurement expertise and product breadth, combined with channel partner convenience.

www.keysight.com/find/pnax

For more information on Keysight Technologies' products, applications or services, please contact your local Keysight office. The complete list is available at:

www.keysight.com/find/contactus

Americas

Canada	(877) 894-4414
Brazil	(11) 4197 3500
Mexico	01800 5064 800
United States	(800) 829-4444

Asia Pacific

Australia	1 800 629 485
China	800 810 0189
Hong Kong	800 938 693
India	1 800 112 929
Japan	0120 (421) 345
Korea	080 769 0800
Malaysia	1 800 888 848
Singapore	1 800 375 8100
Taiwan	0800 047 866
Other AP Countries	(65) 375 8100

Europe & Middle East

Belgium	32 (0) 2 404 93 40
Denmark	45 70 13 15 15
Finland	358 (0) 10 855 2100
France	0825 010 700*
	*0.125 €/minute
Germany	49 (0) 7031 464
Ireland	6333
Israel	1890 924 204
Italy	972-3-9288-504/544
Netherlands	39 02 92 60 8 484
Spain	31 (0) 20 547 2111
Sweden	34 (91) 631 3300
United Kingdom	0200-88 22 55
	44 (0) 118 9276201

For other unlisted countries:

www.keysight.com/find/contactus



This information is subject to change without notice.

© Keysight Technologies 2014

Print Date: October 20, 2014

Supersedes: Sept. 15, 2014

N5227-90003

www.keysight.com